

Fig: 10.

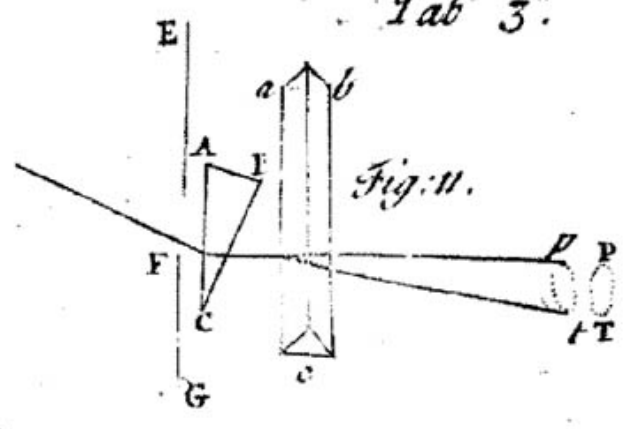

Fig: 11.

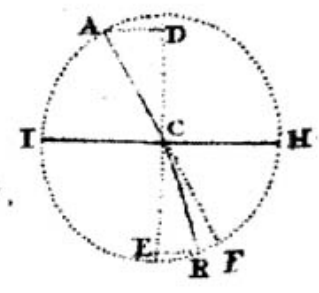

Fig. 13.

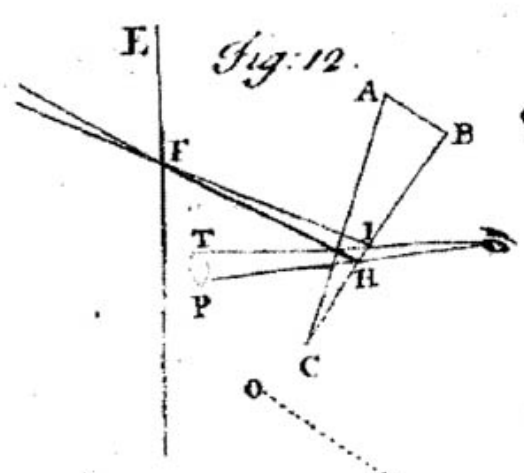

Fig: 12.

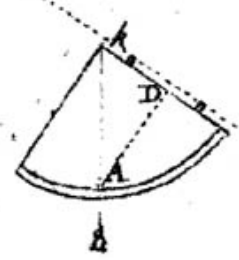

Fig: 15.

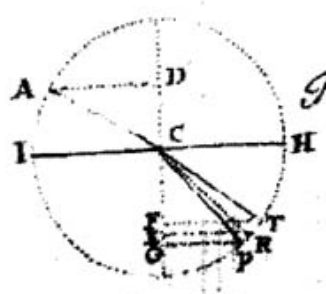
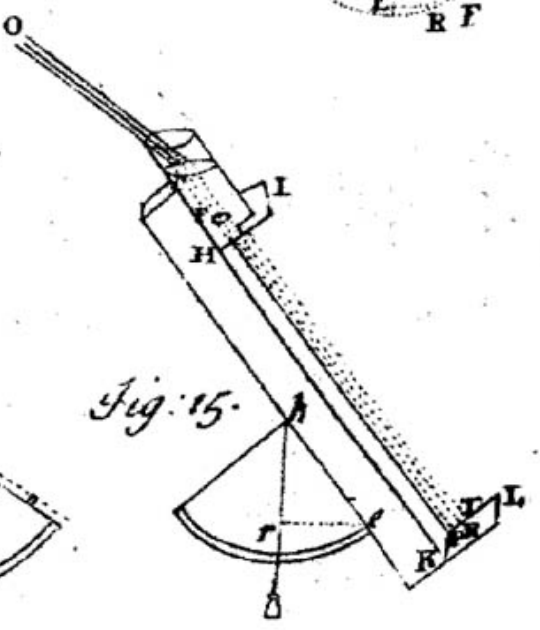
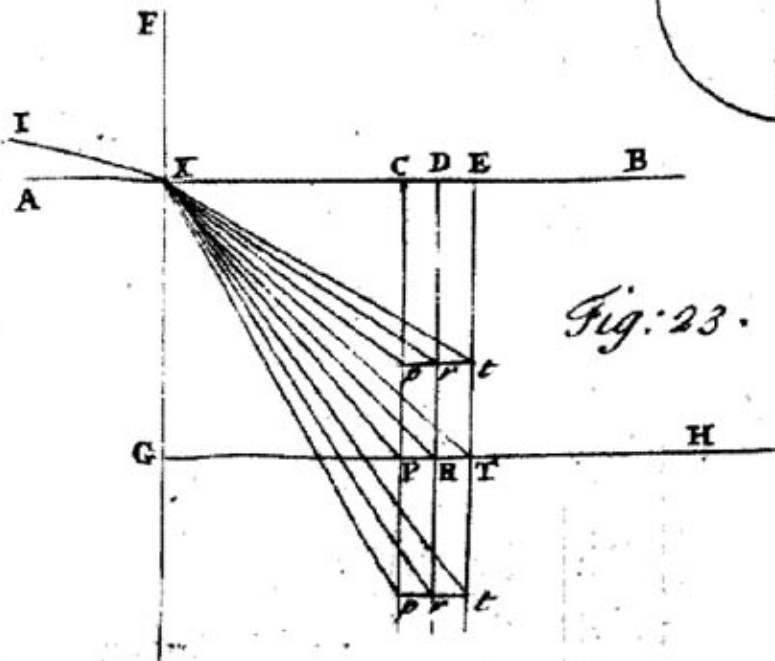
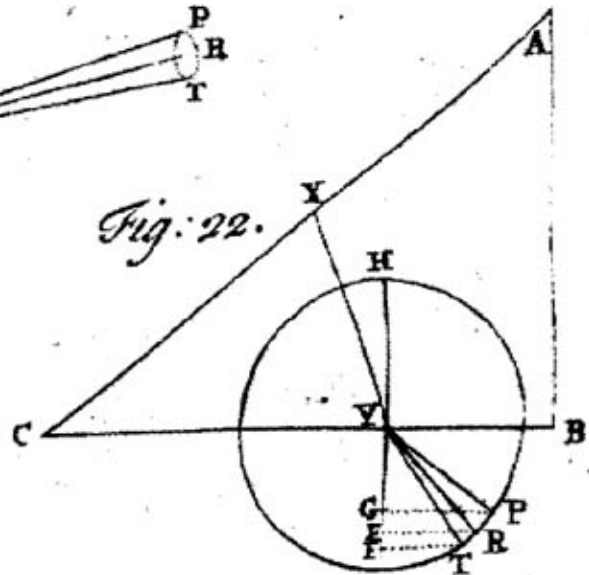
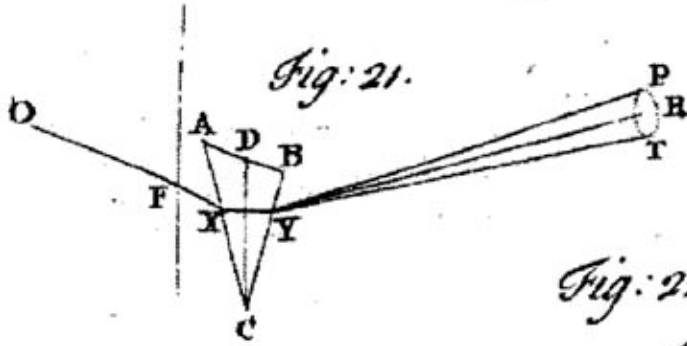
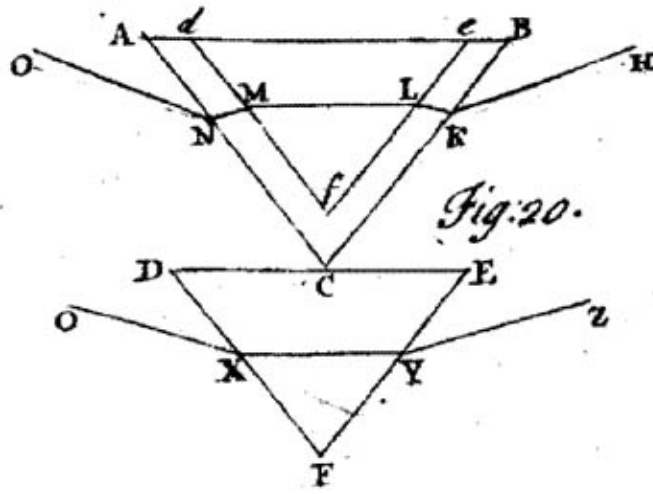
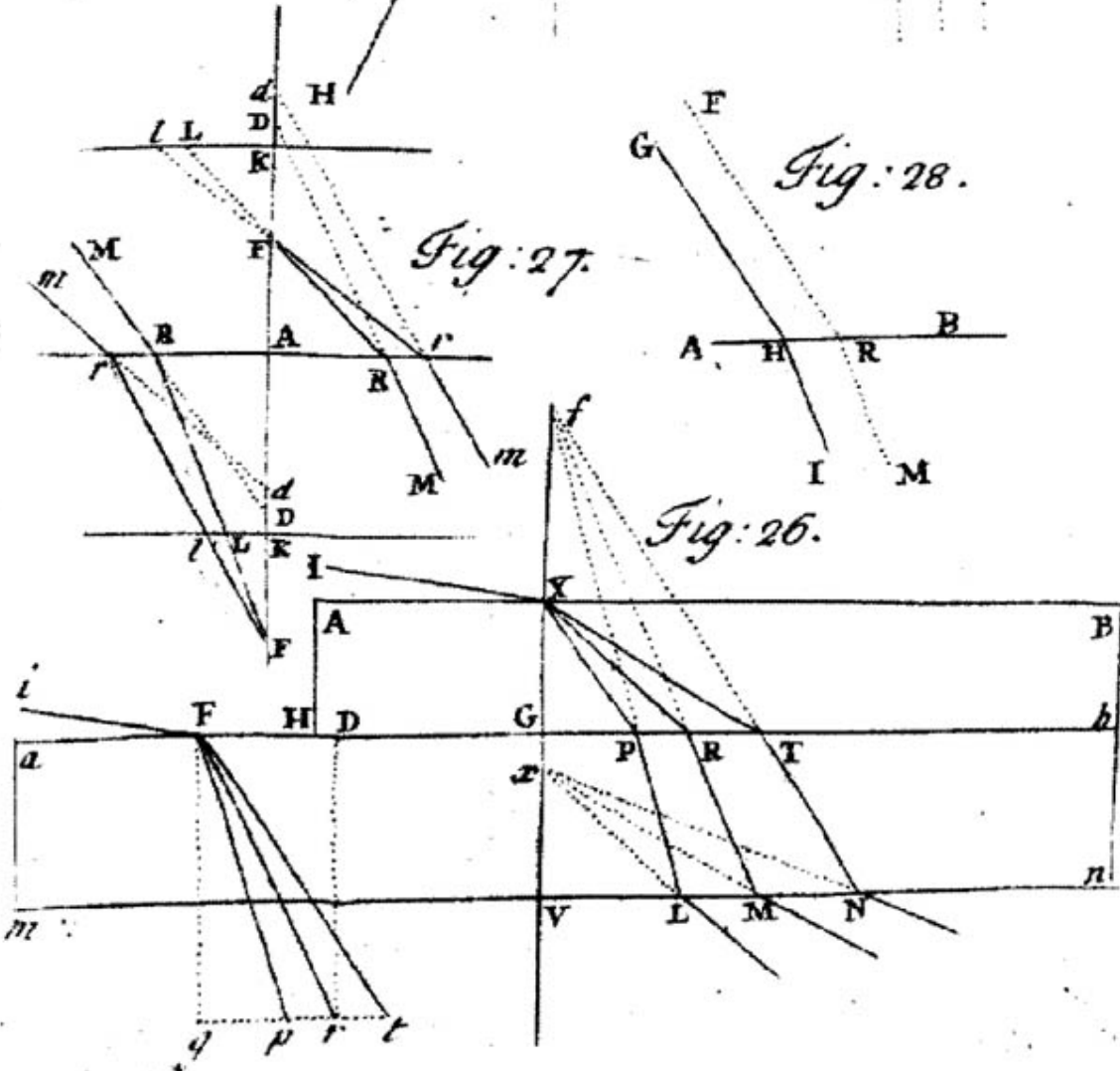
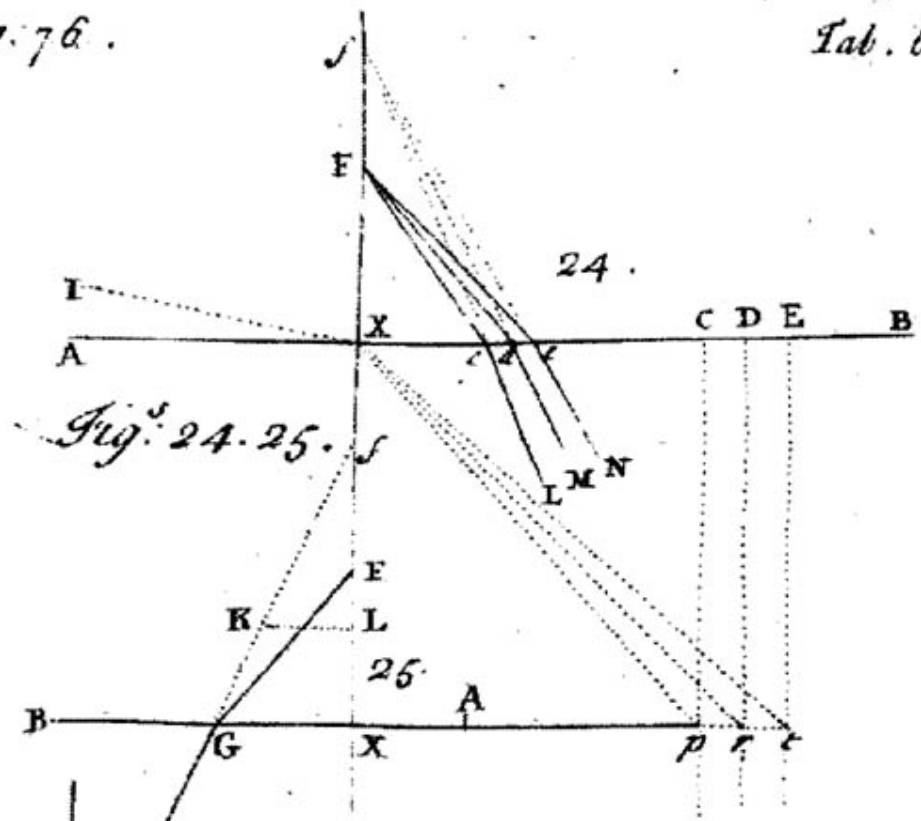

Fig: 14.







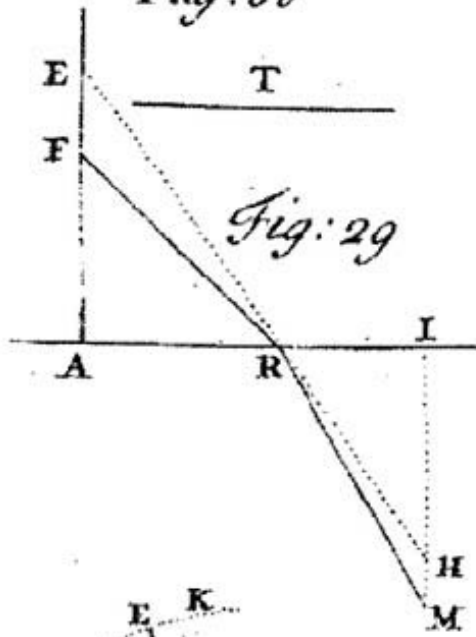

Fig: 29

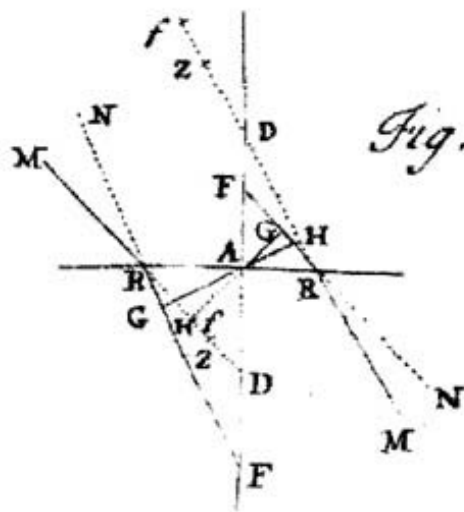

Fig: 30.

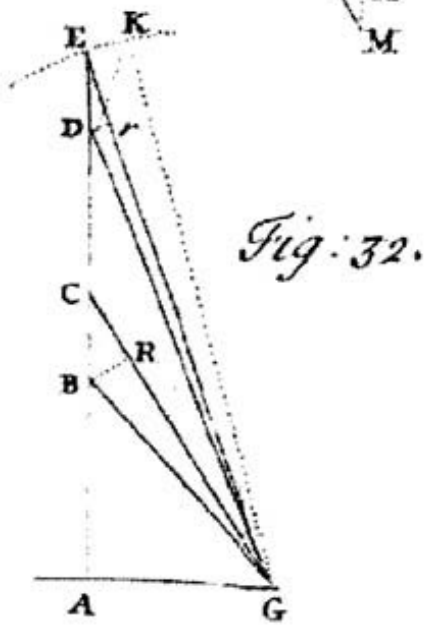

Fig: 32.

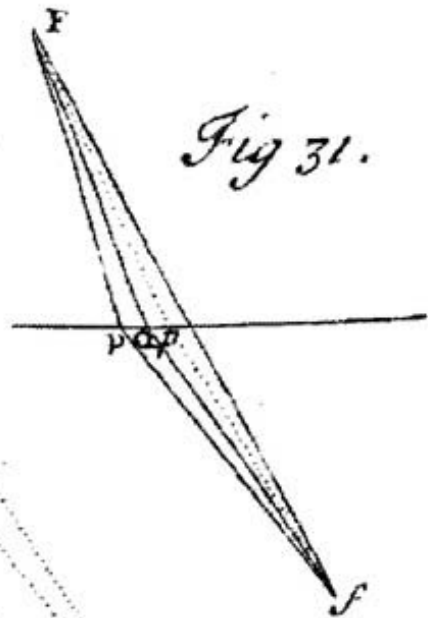

Fig 31.

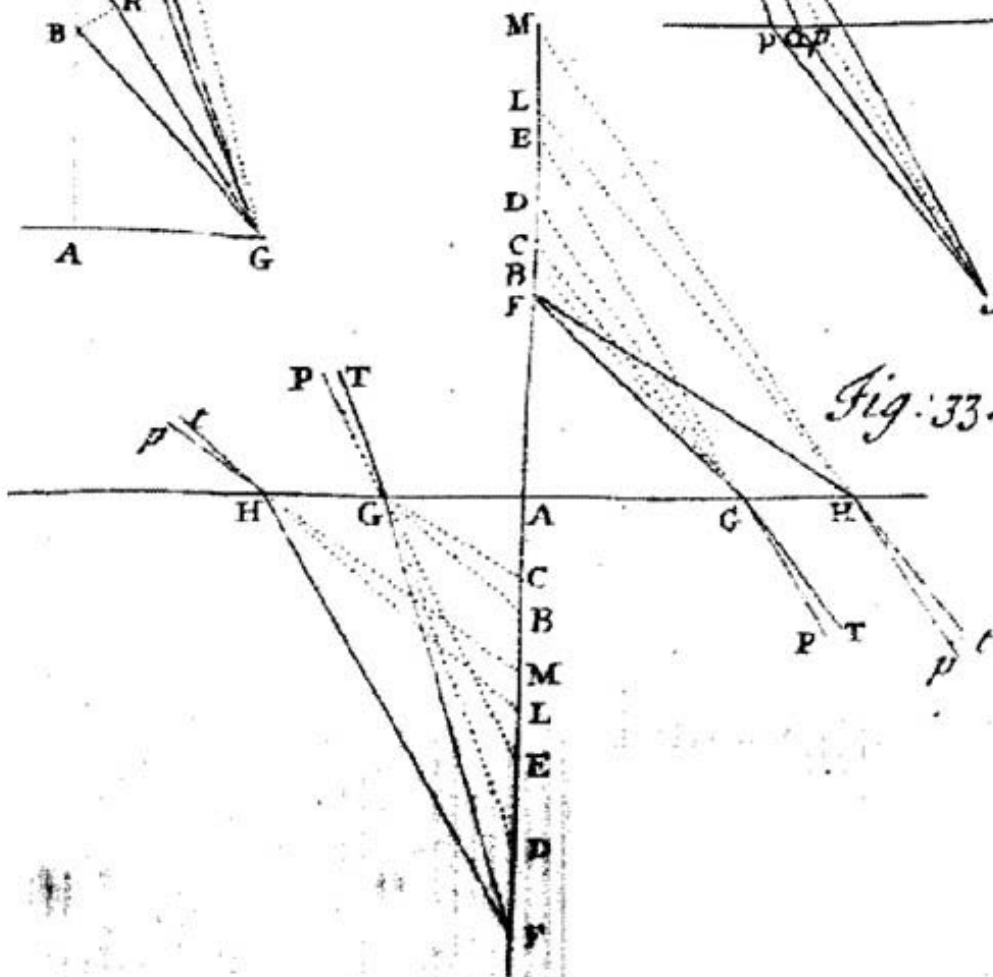

Fig: 33.

Fig: 34.

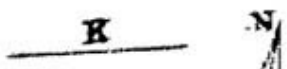
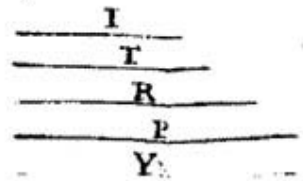
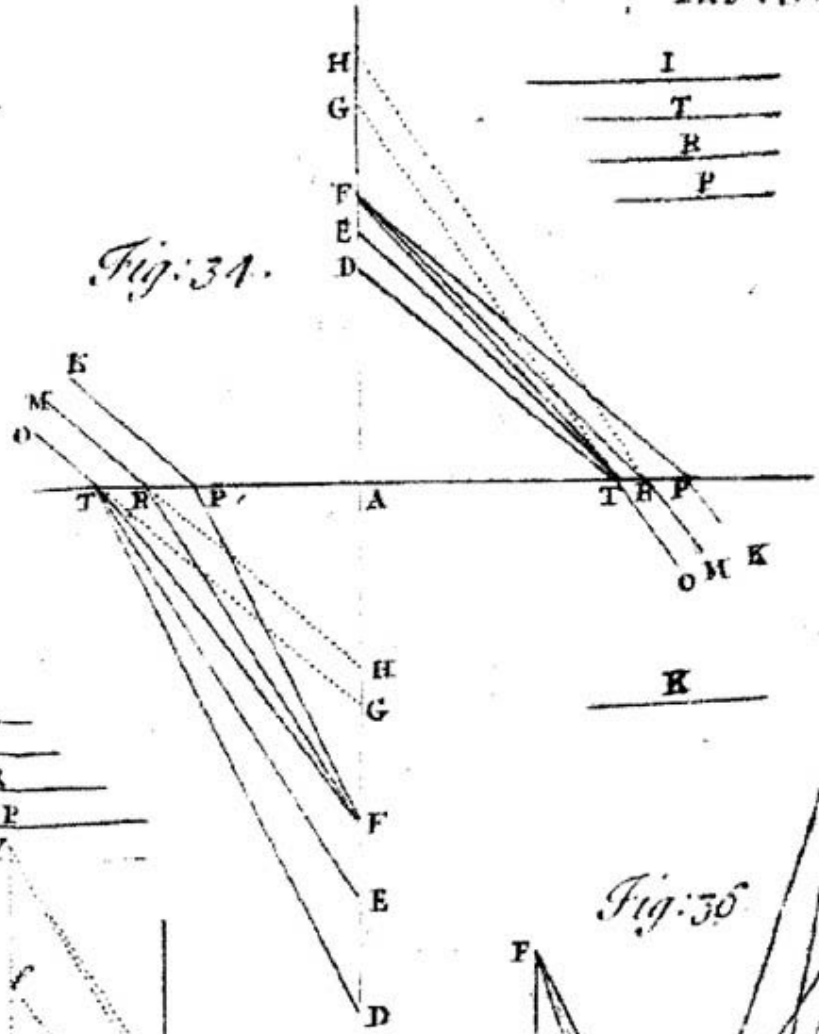
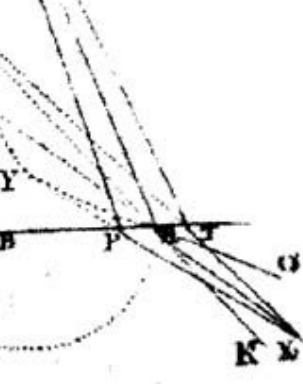
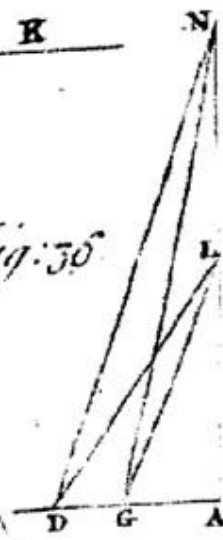
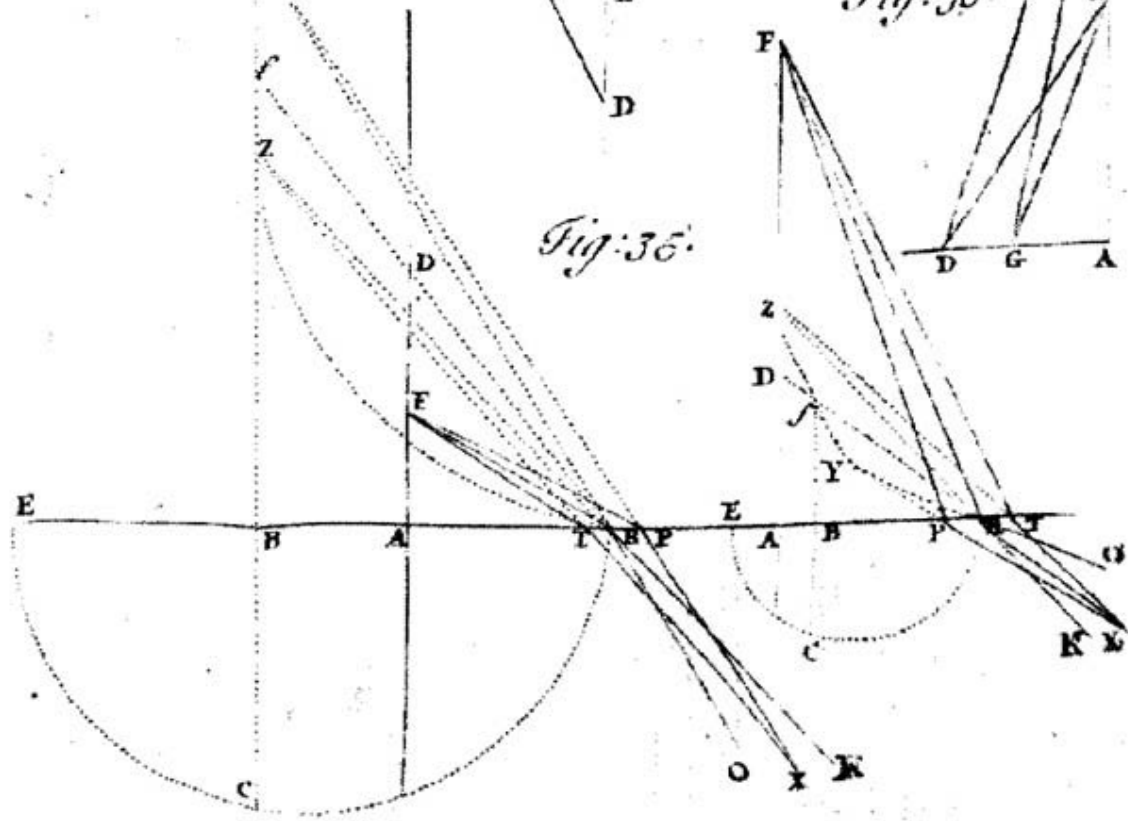
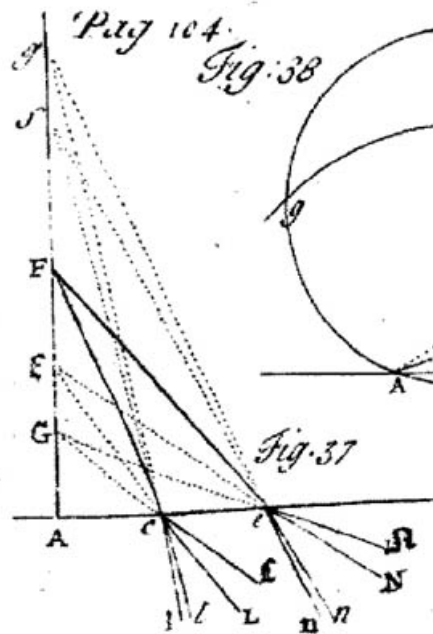

Fig: 35.







Tab. 9.

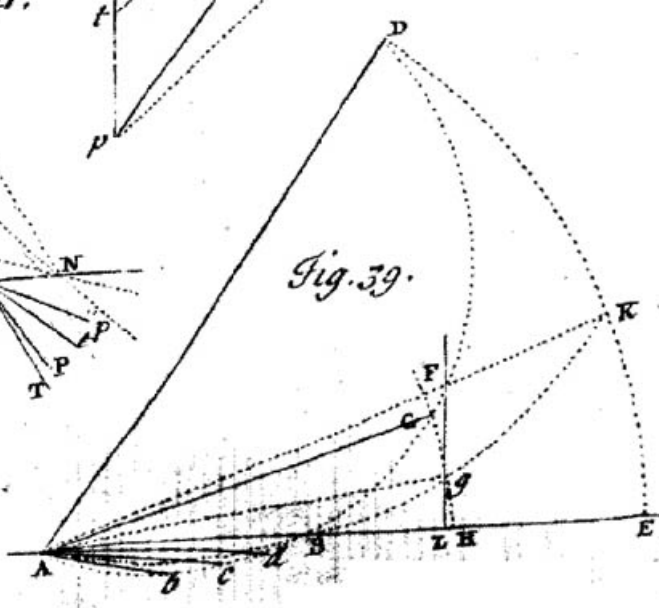
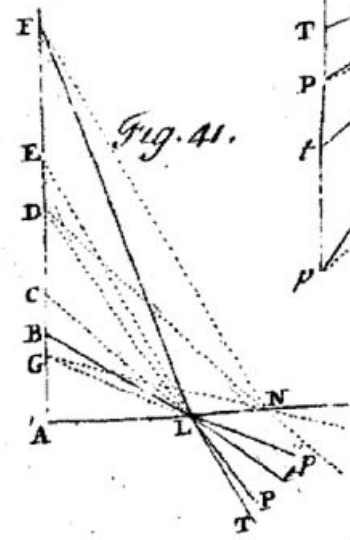
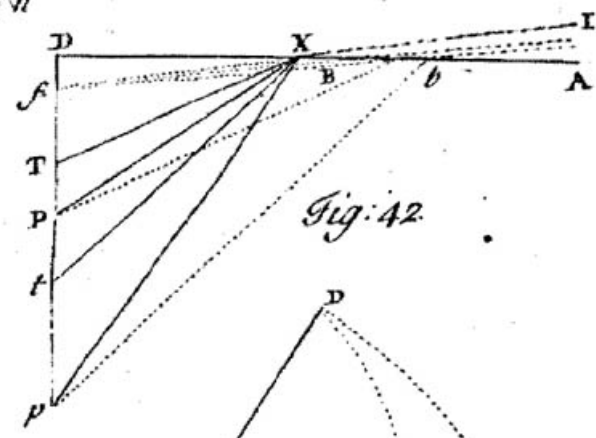
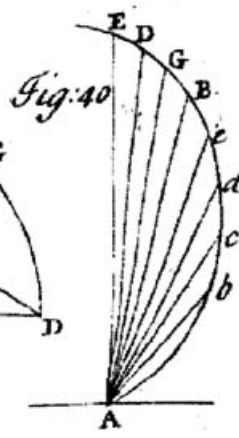

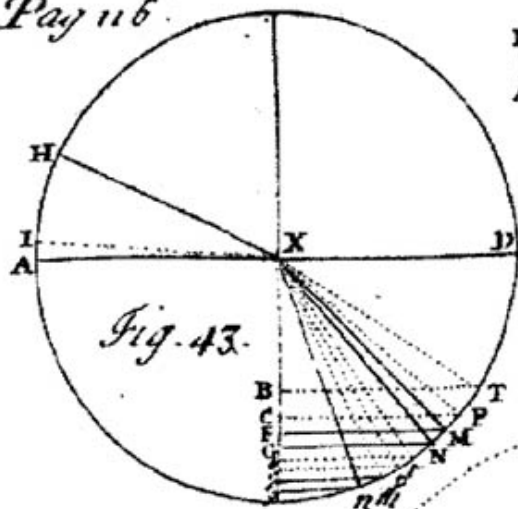

Fig. 43.

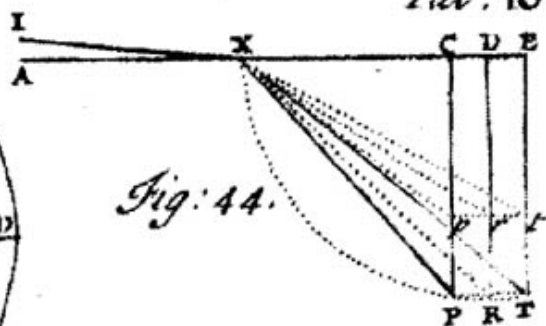

Fig: 44.

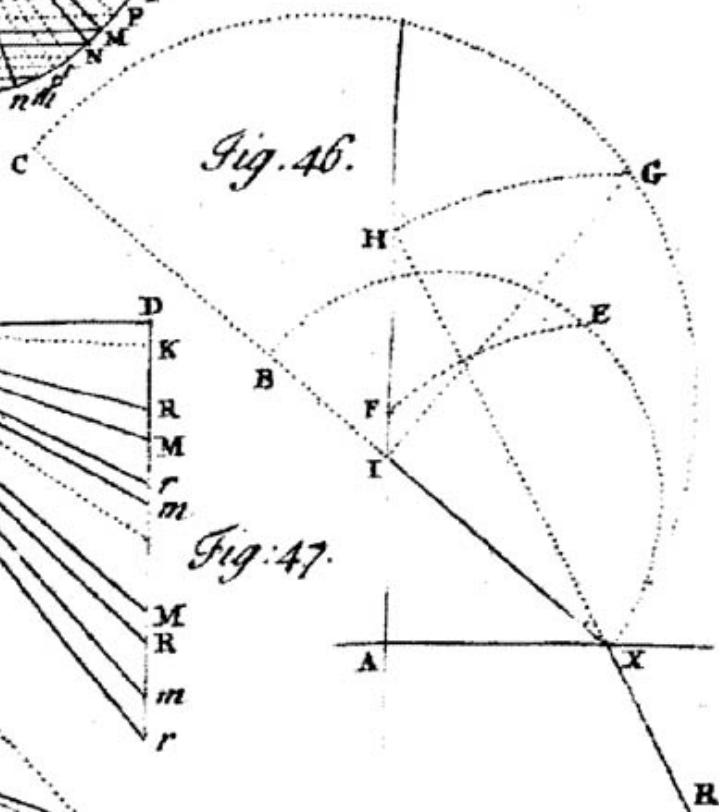

Fig. 46.

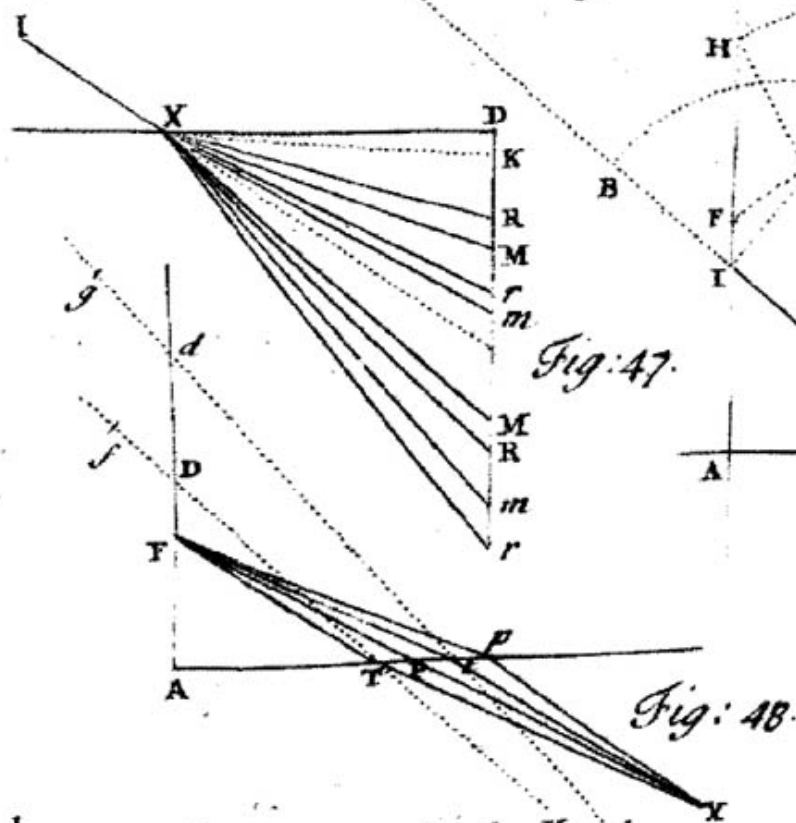

Fig: 47.

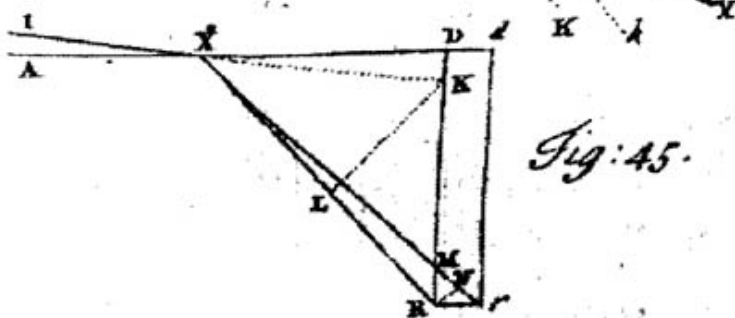

Fig: 45.

Fig: 48.

