

Fig. 1.

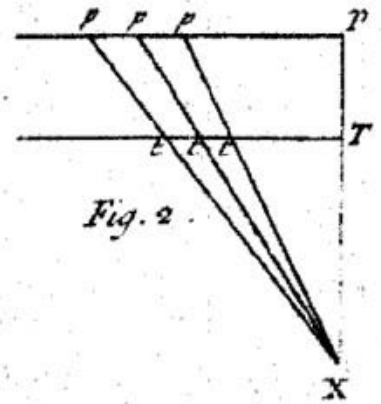

Fig. 2.

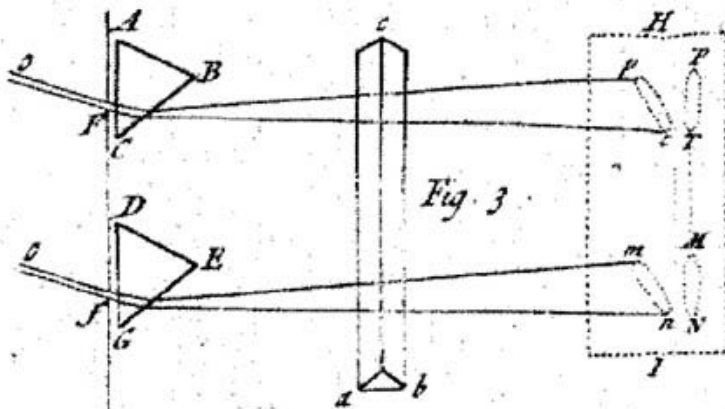

Fig. 3.

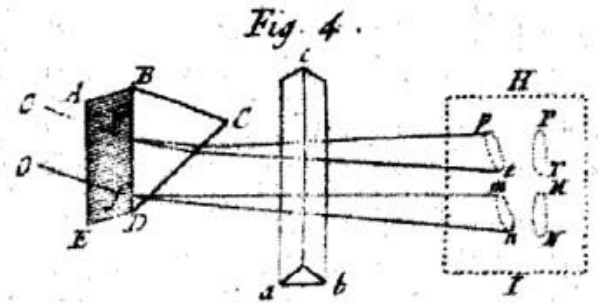

Fig. 4.

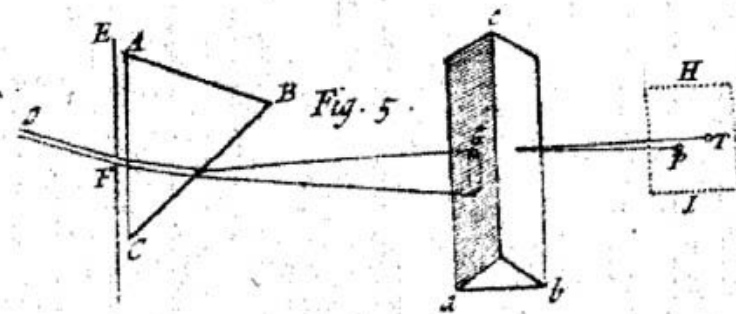

Fig. 5.

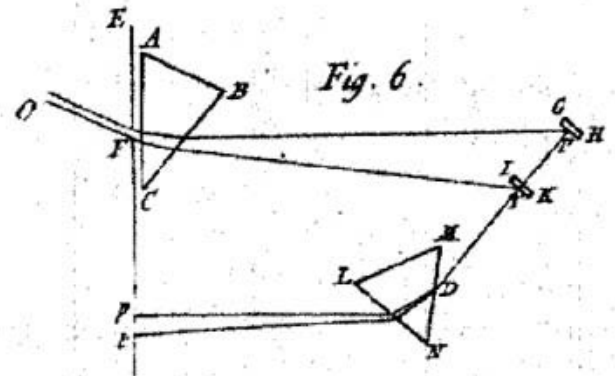

Fig. 6.

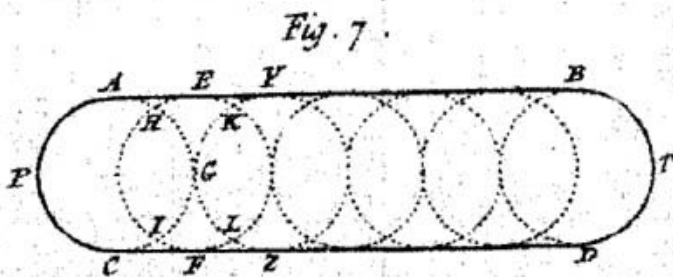

Fig. 7.

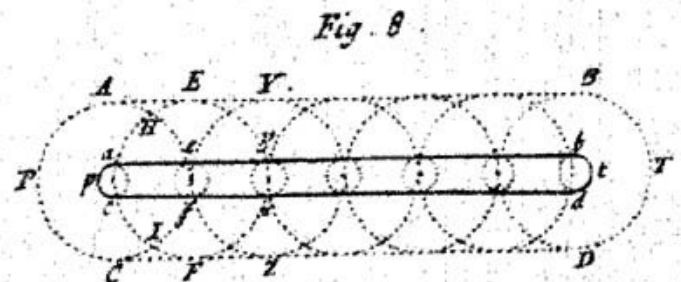

Fig. 8.

Fig. 9

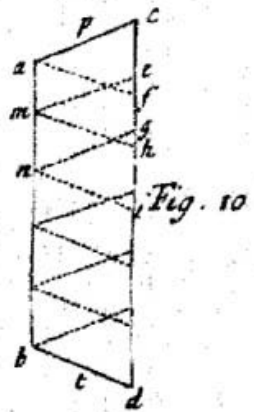
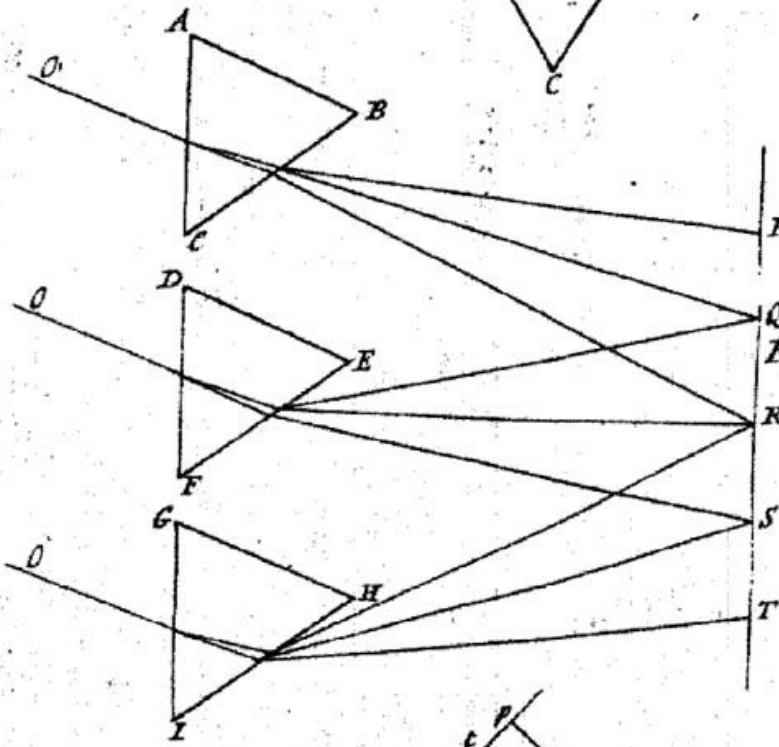
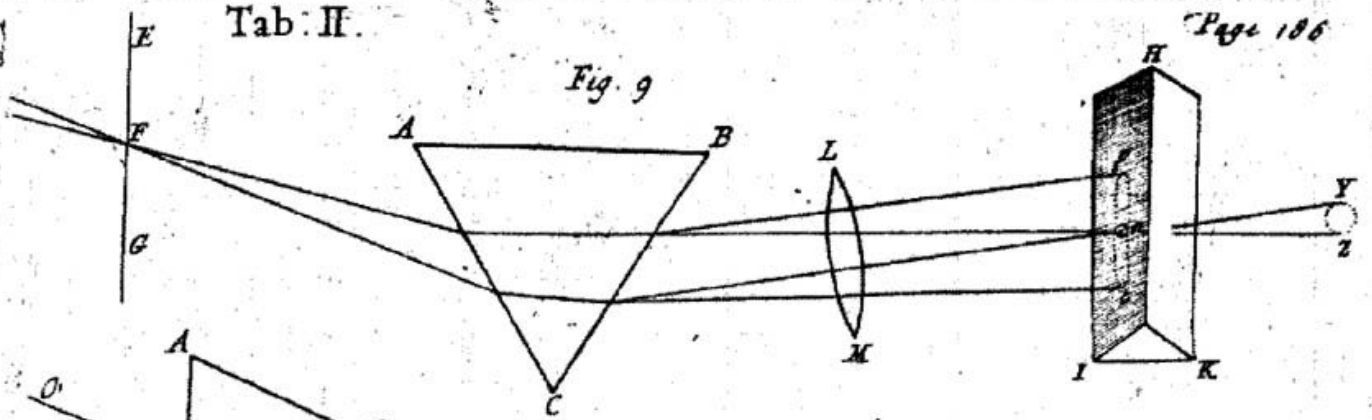

Fig. 11.

Fig. 10.

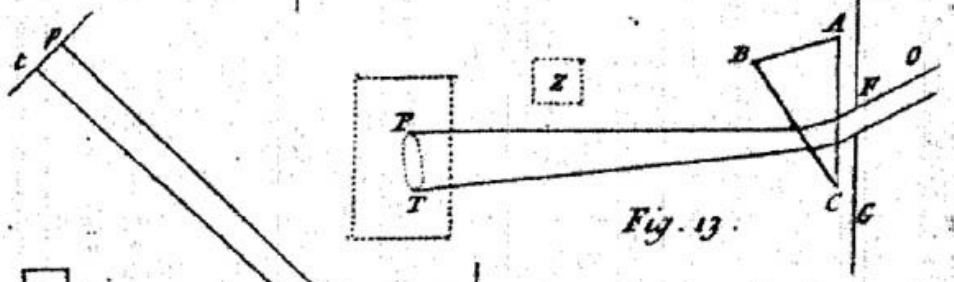
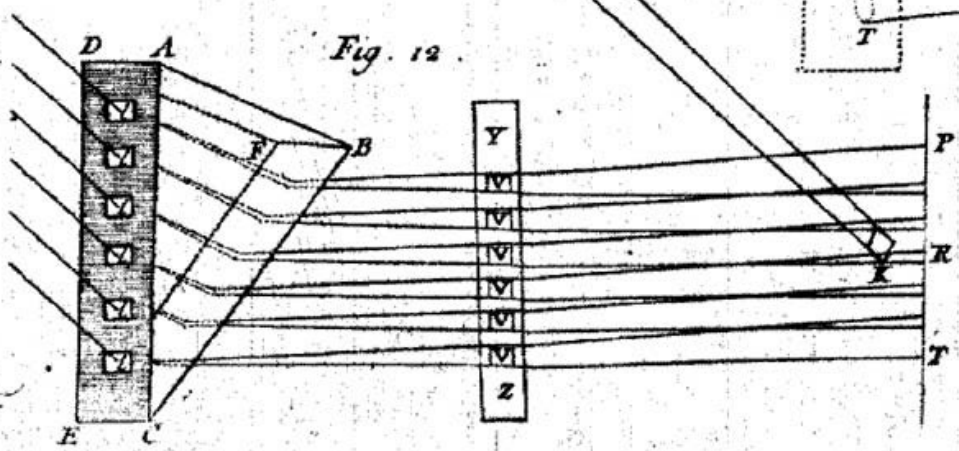
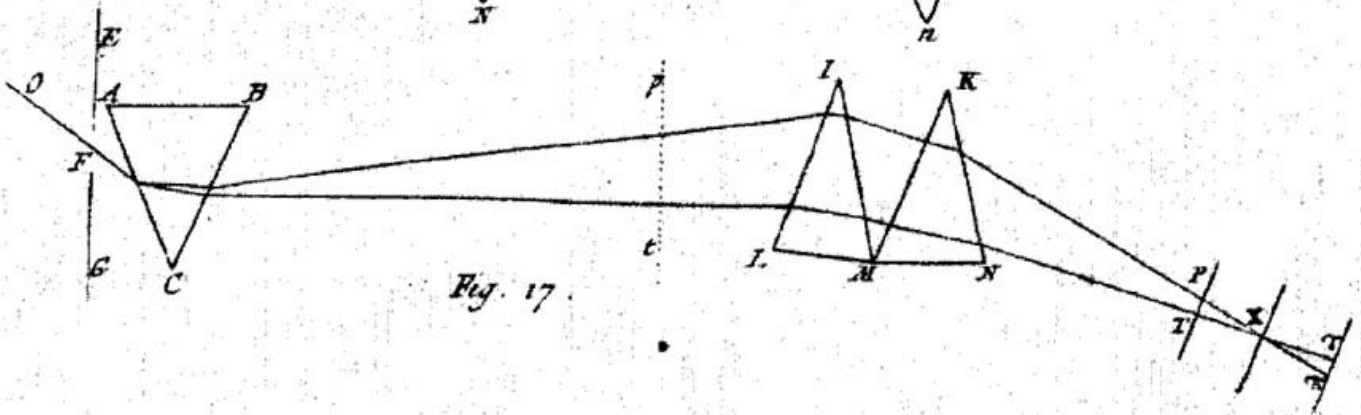
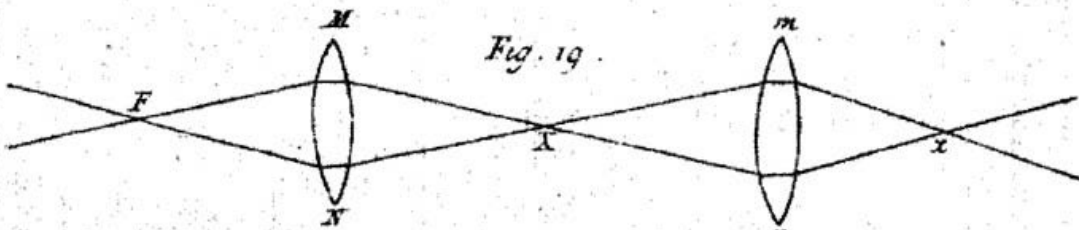
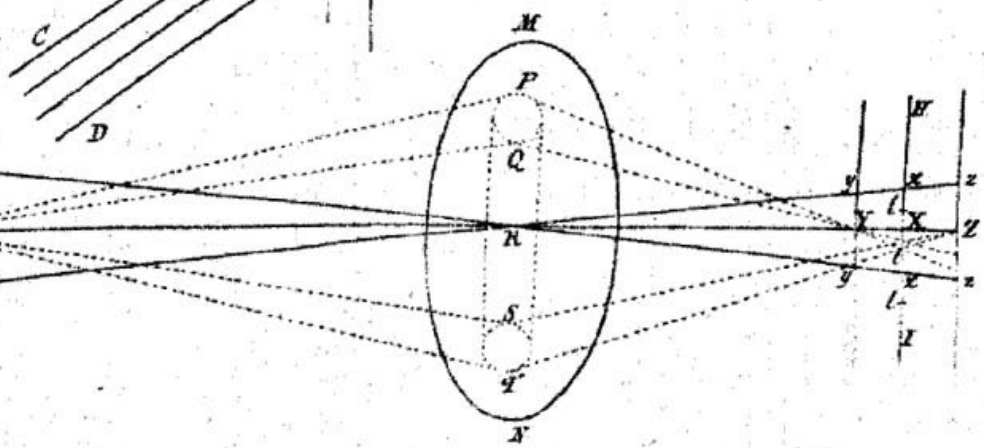
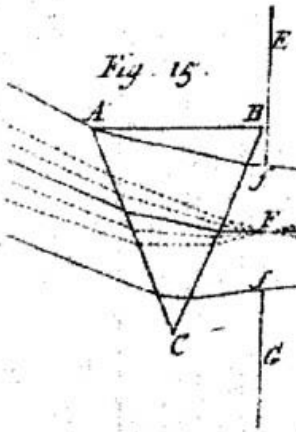
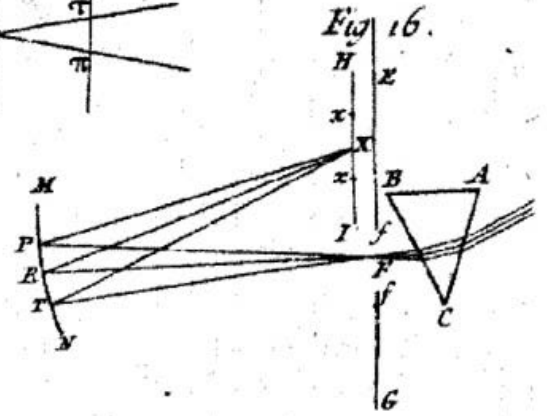
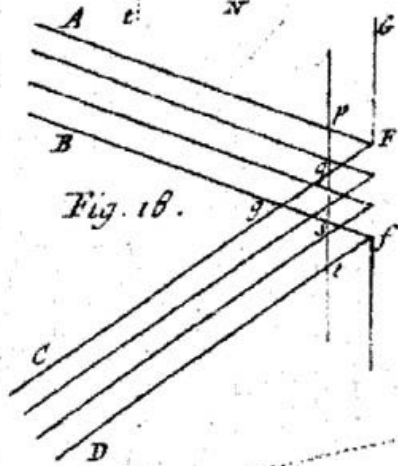
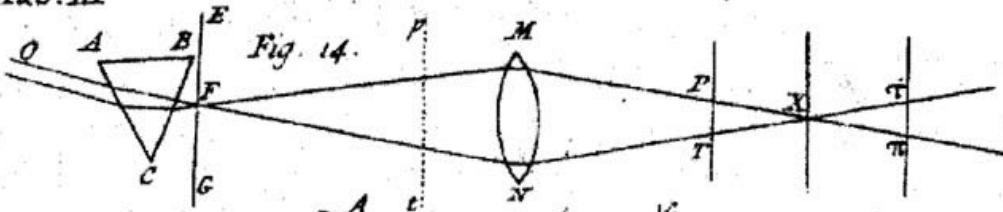

Fig. 13.

Fig. 12.





Tab. IV.

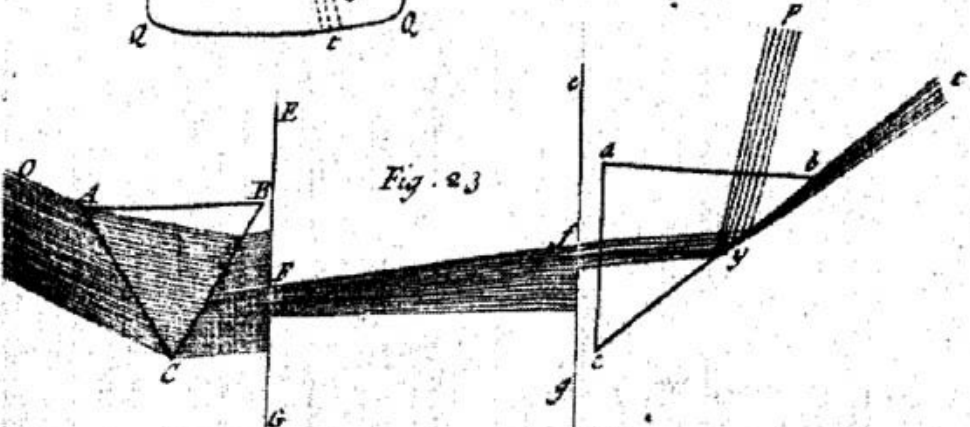
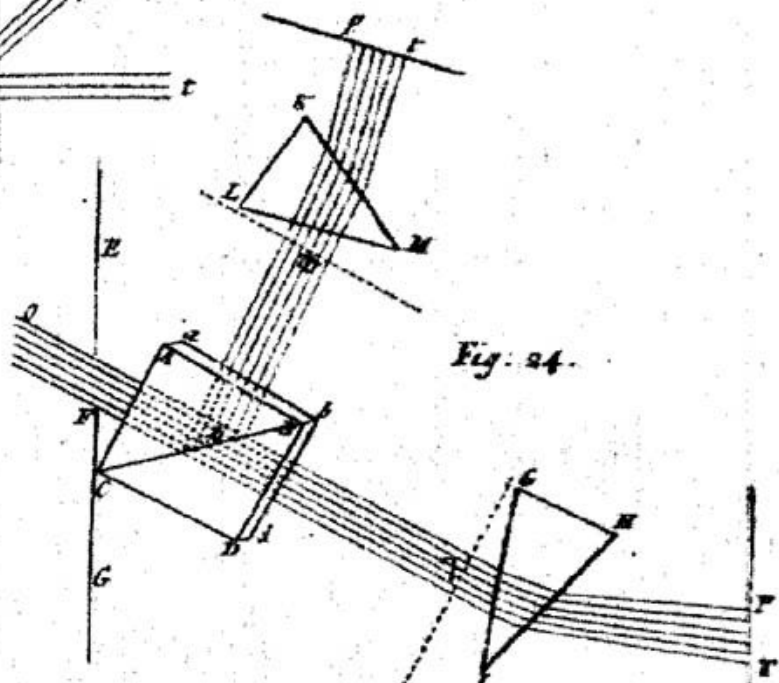
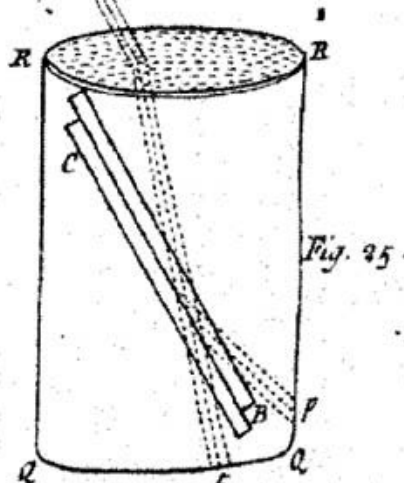
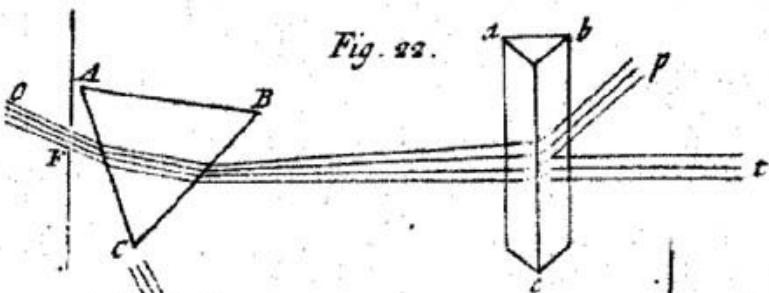
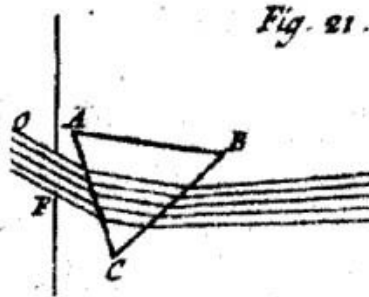
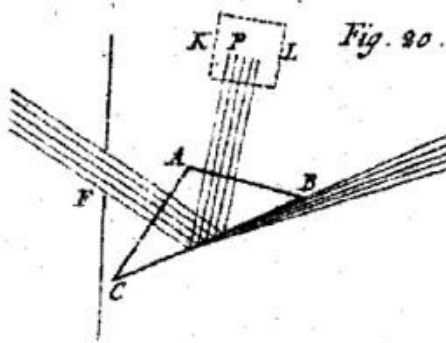

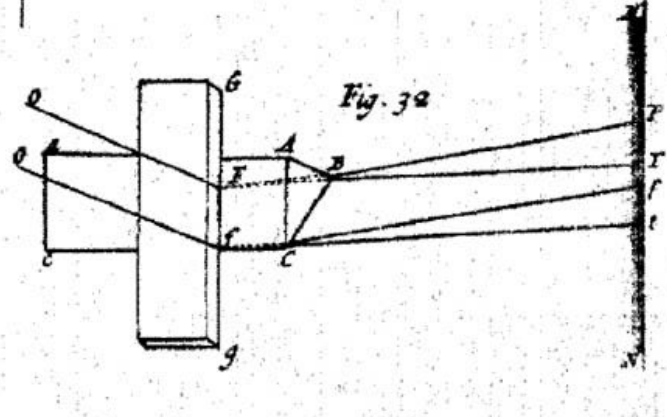
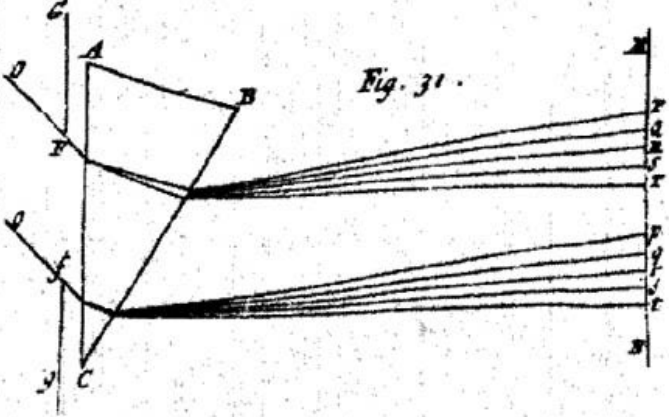
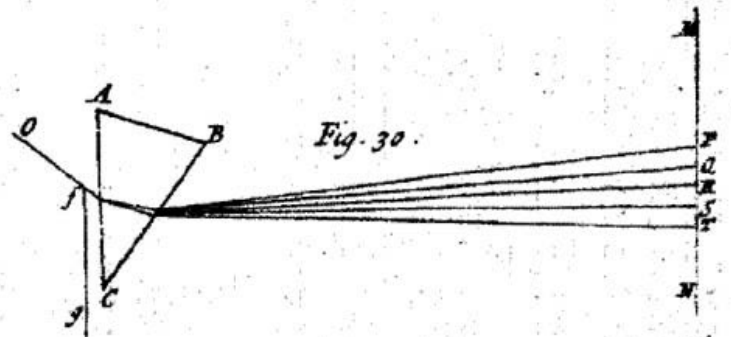
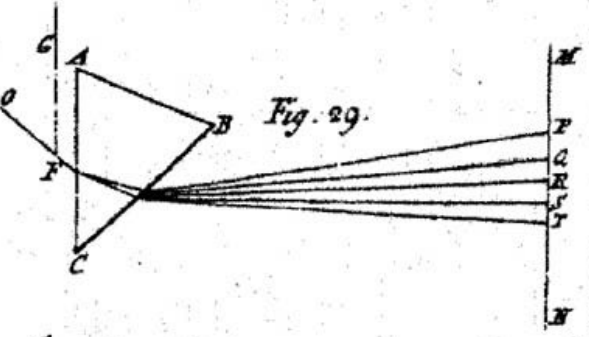
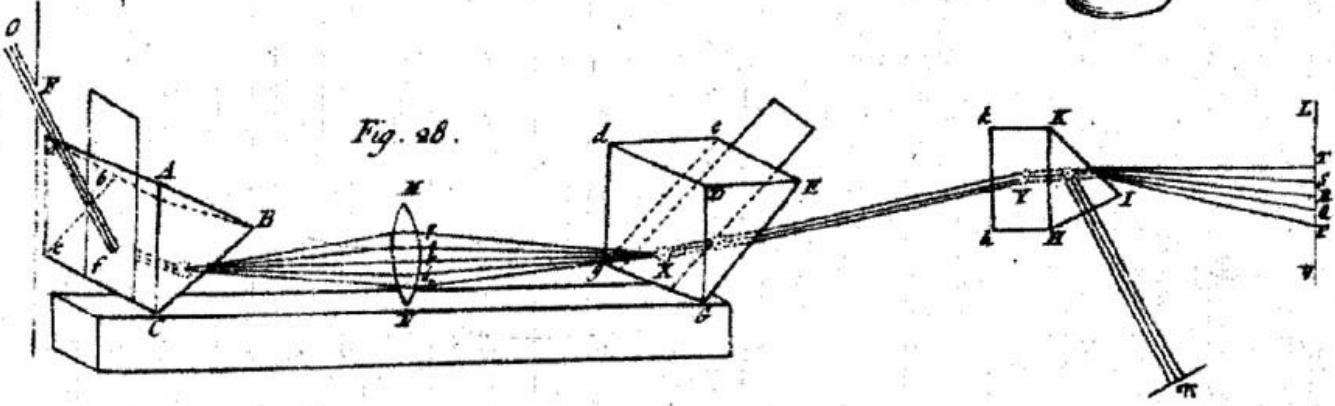
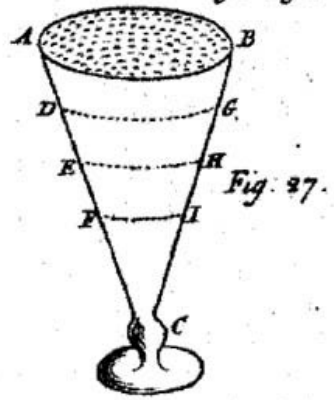
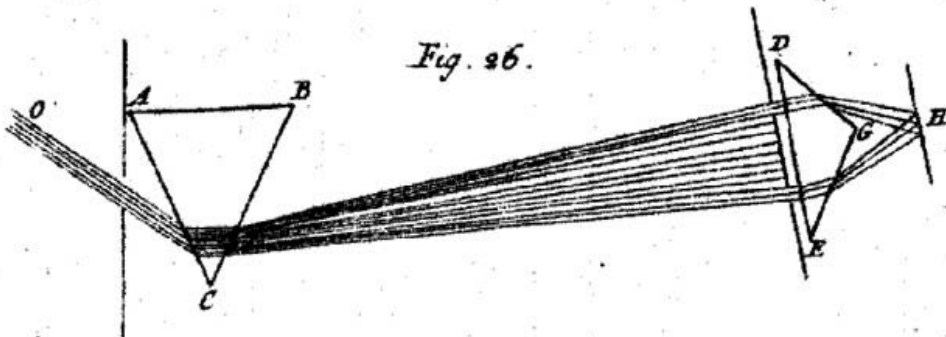

Tab. VI.

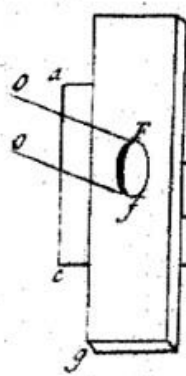

Fig. 33.

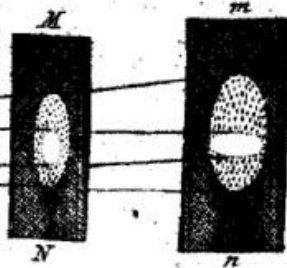

Fig. 34.

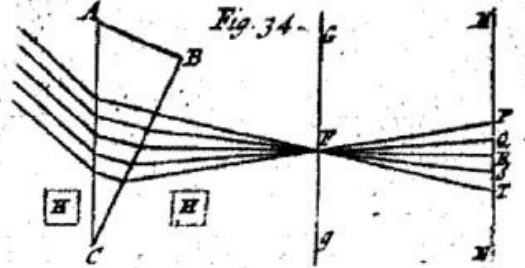

Fig. 35.

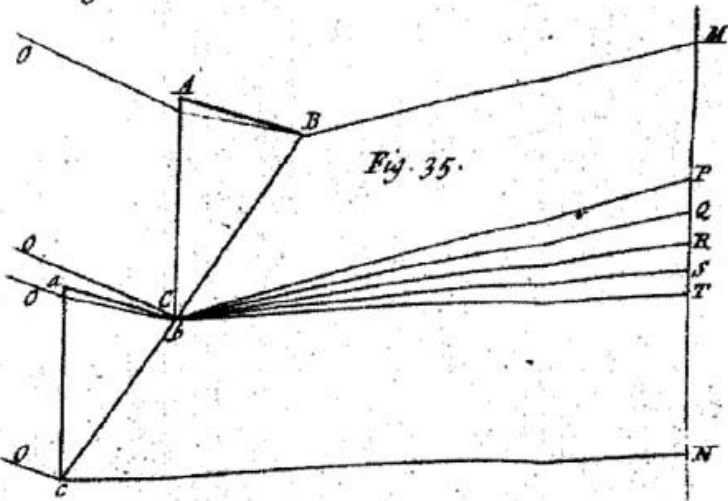

Fig. 36.

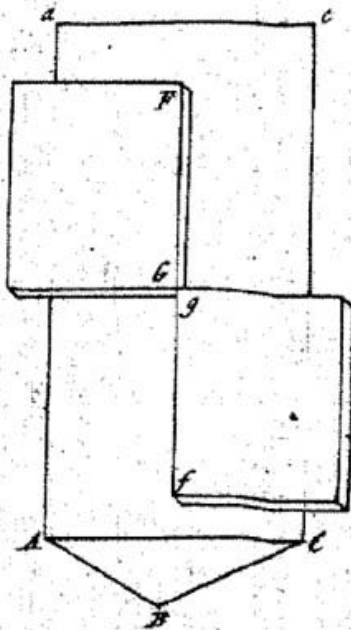
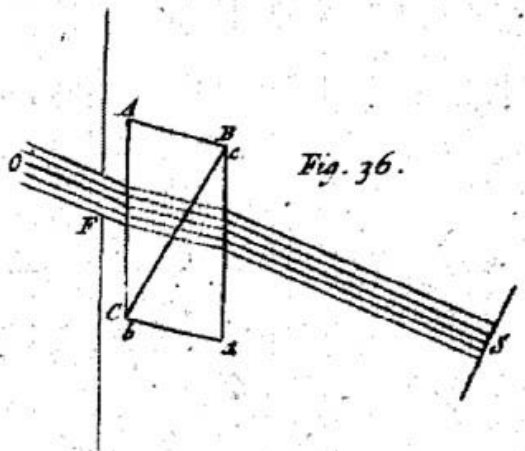
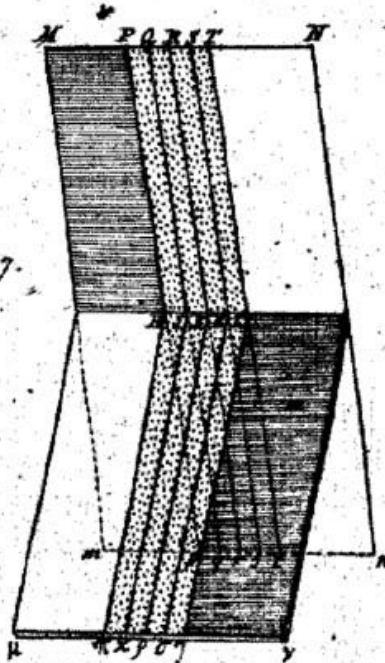
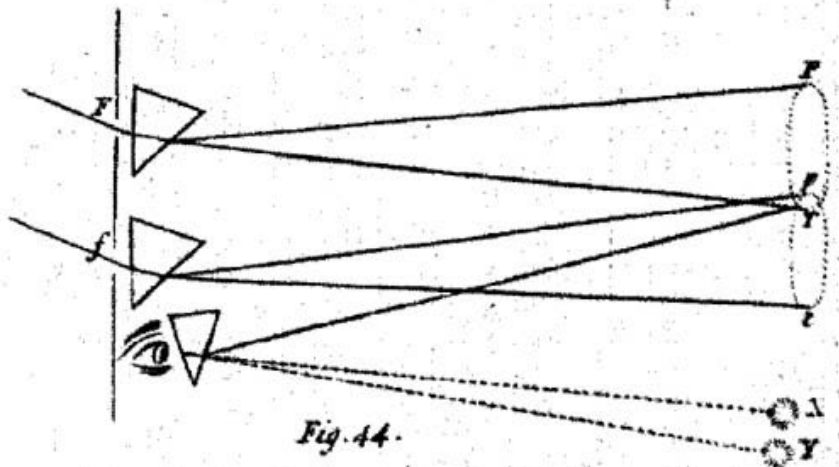
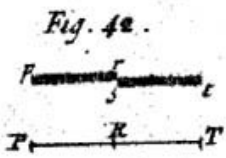
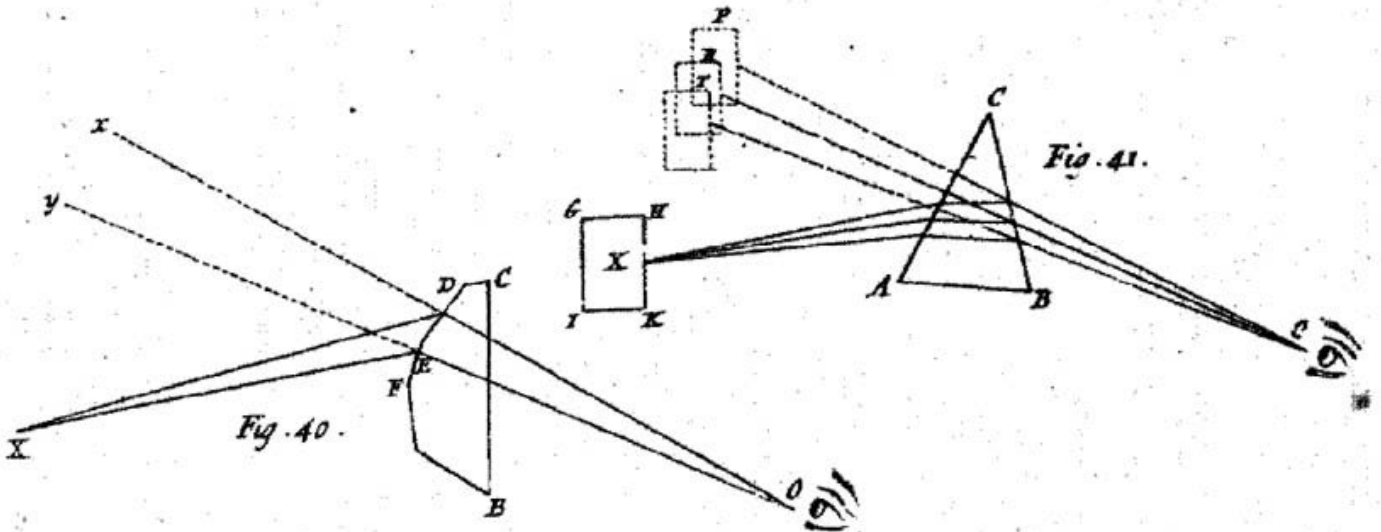
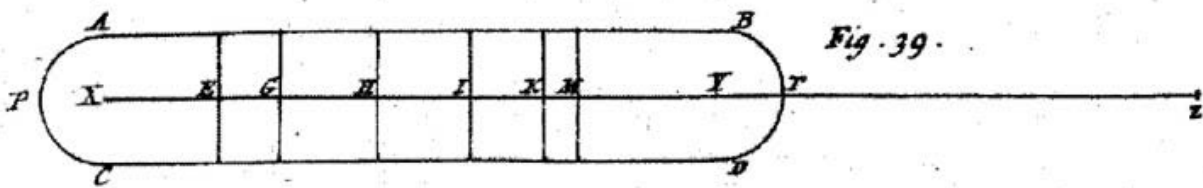
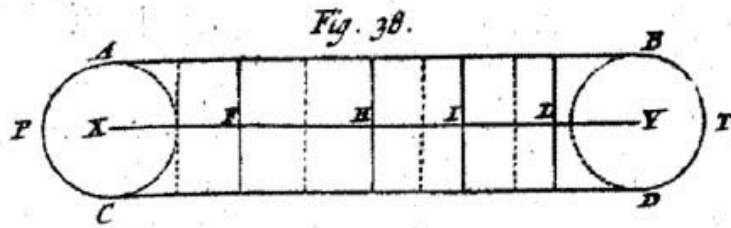

Fig. 37.



Tab. VII.



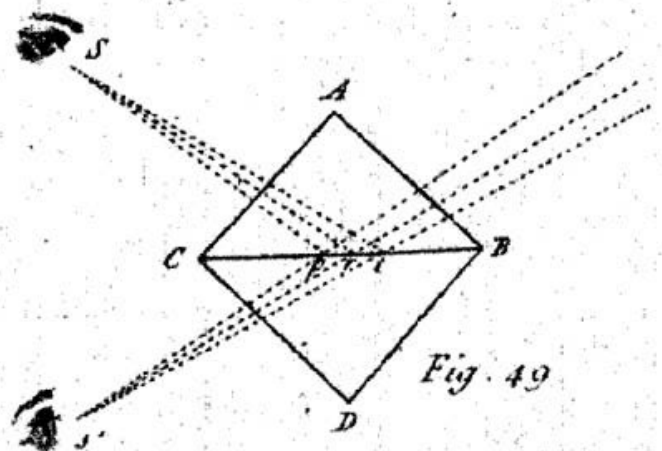
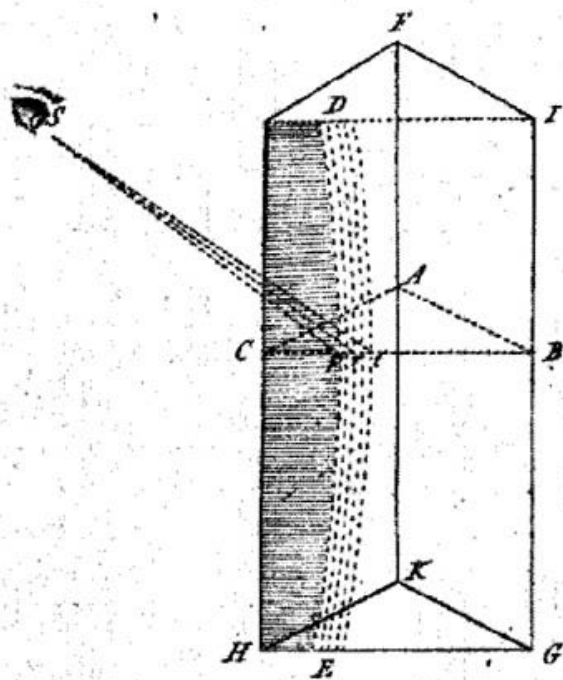
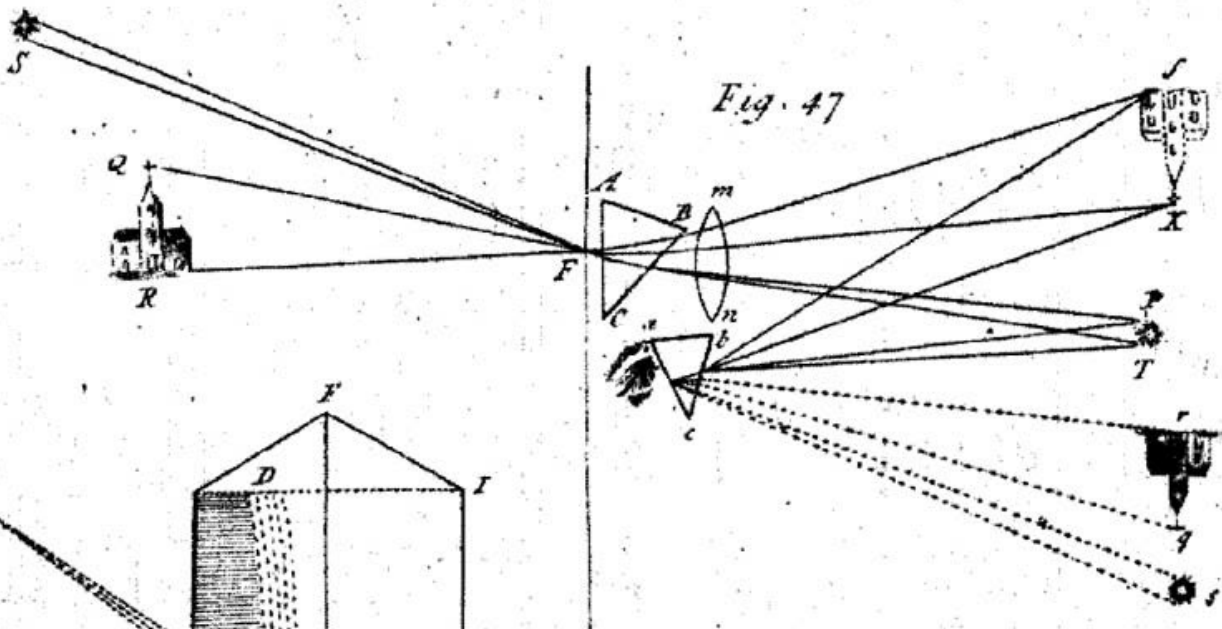
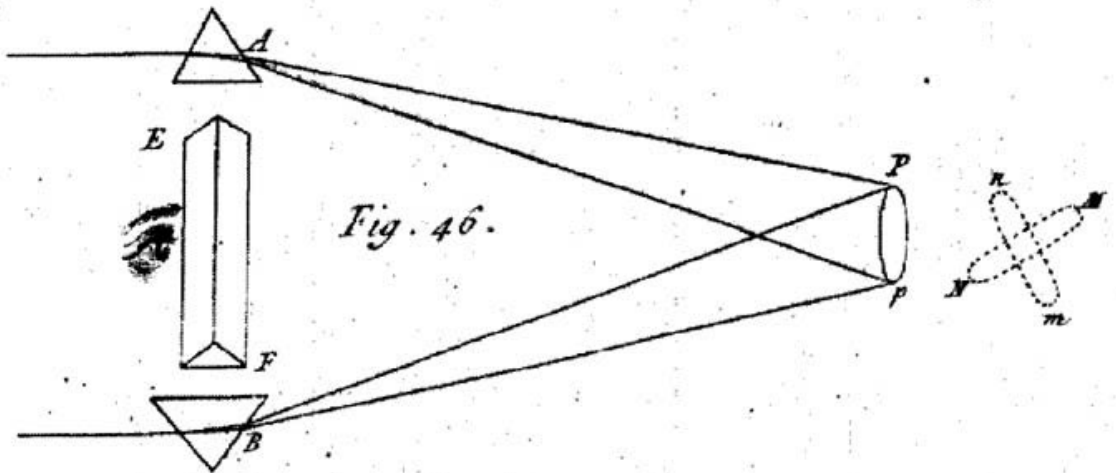
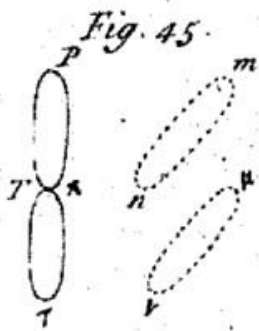



Fig. 50.

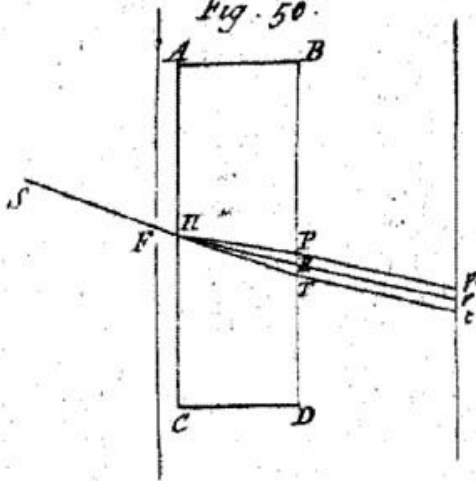

Fig. 51.

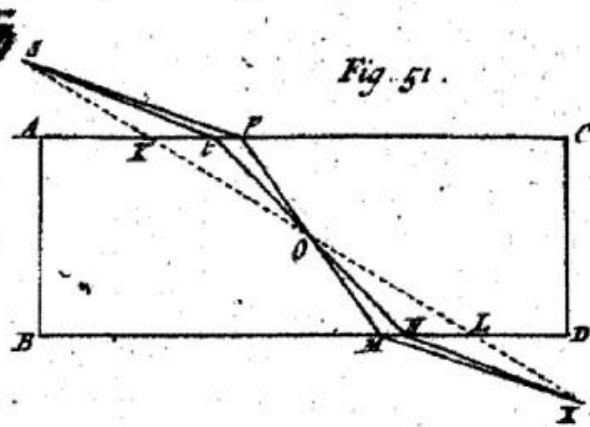

Fig. 53.

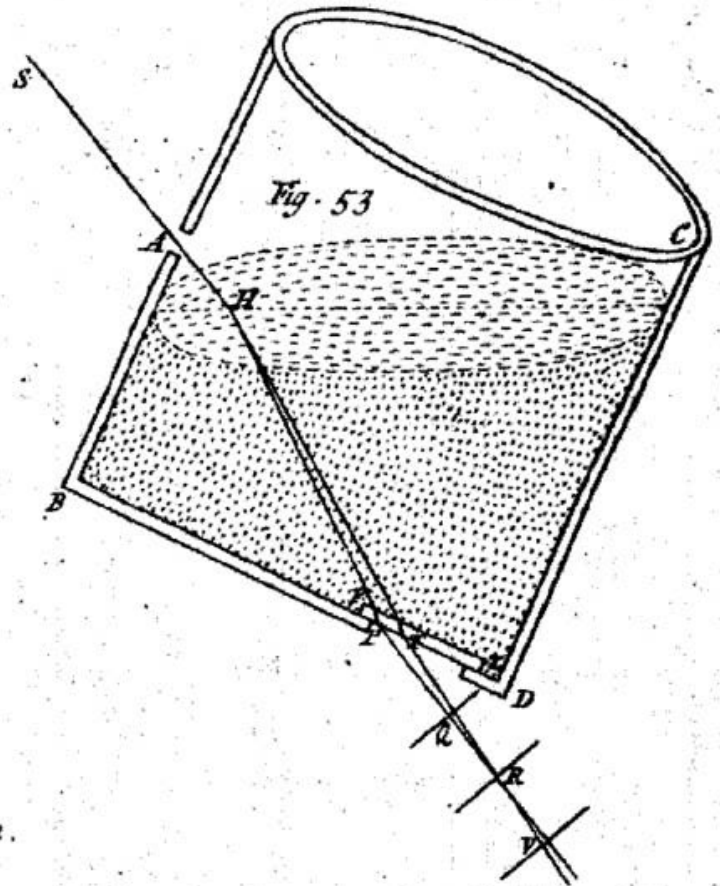

Fig. 54.

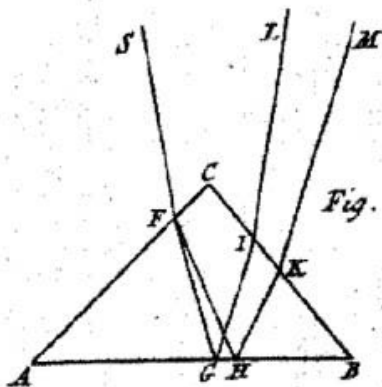

Fig. 52.

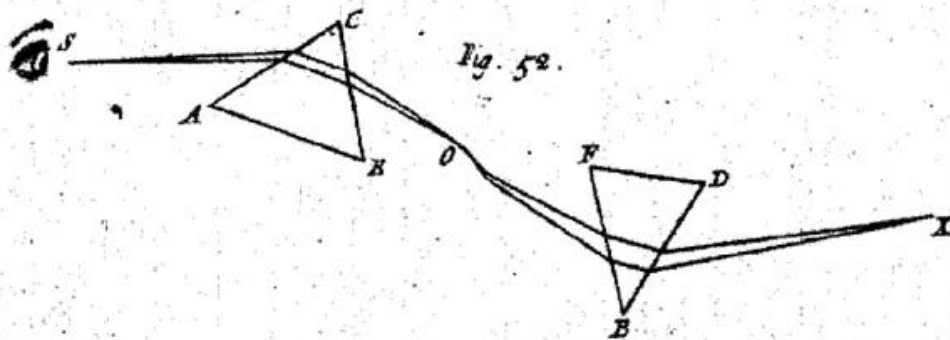

Fig. 55.

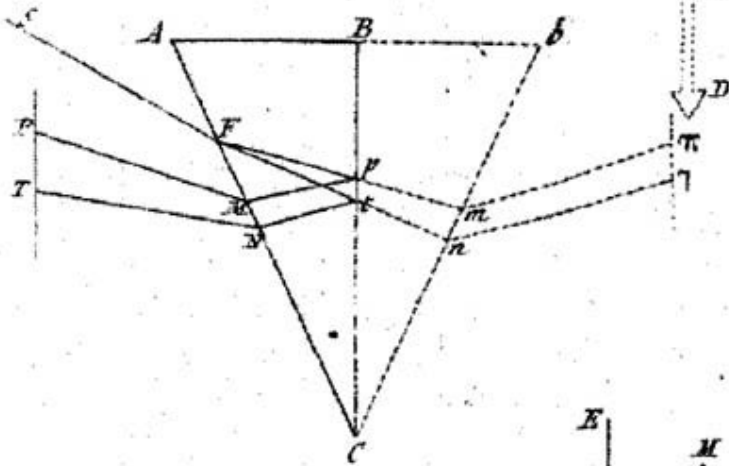

Fig 57.

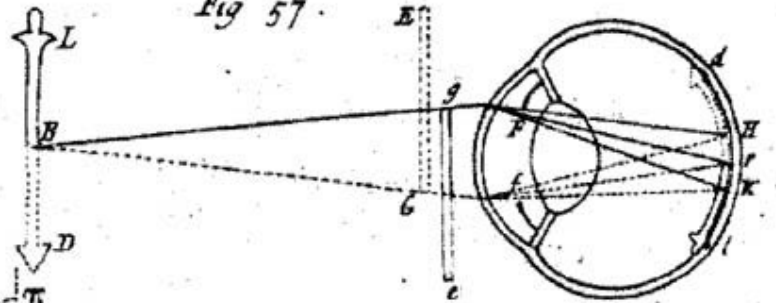

Fig. 56.

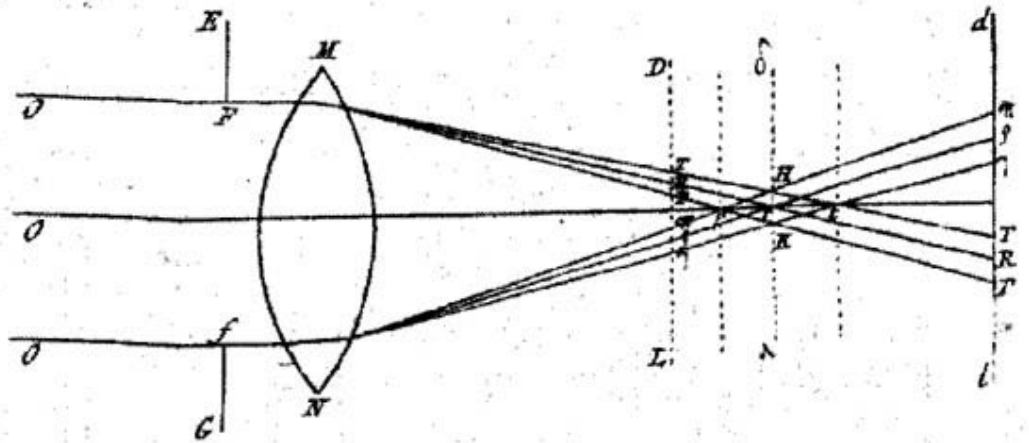

Fig. 59.

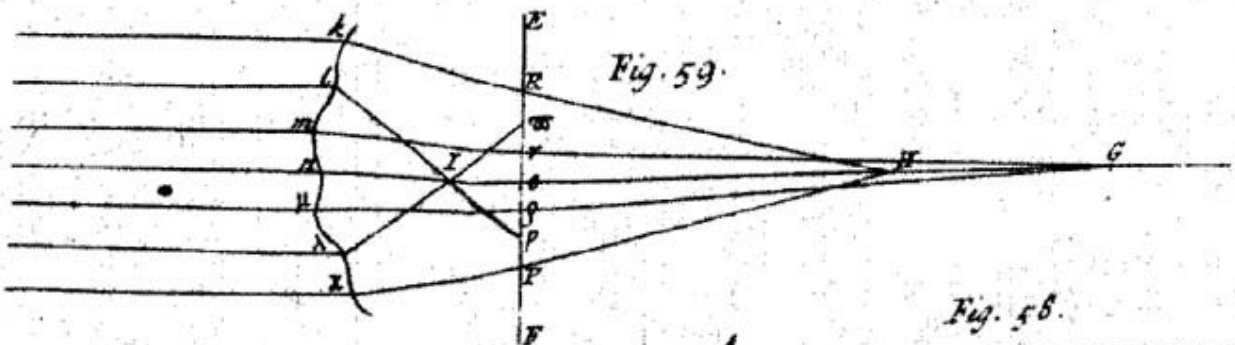
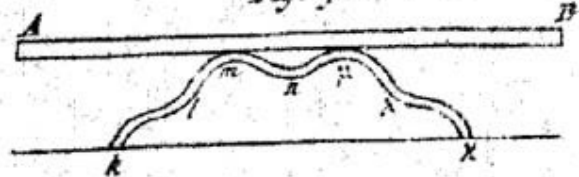

Fig. 58.



Tab. XI.

Fig. 60.

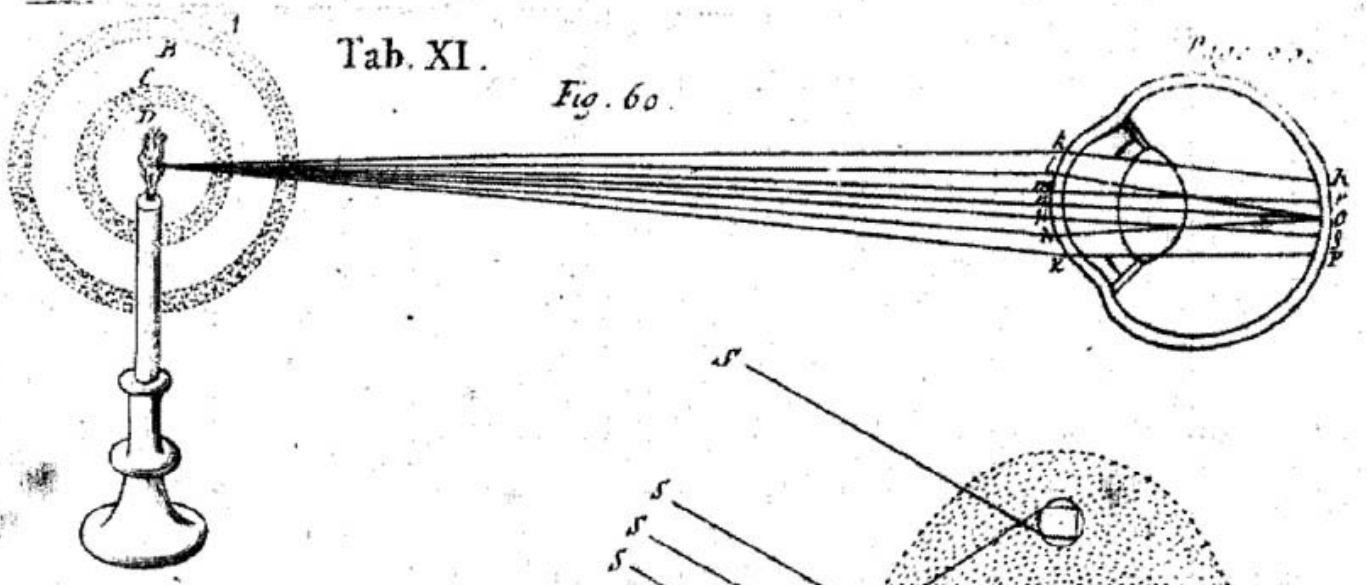

Fig. 62.

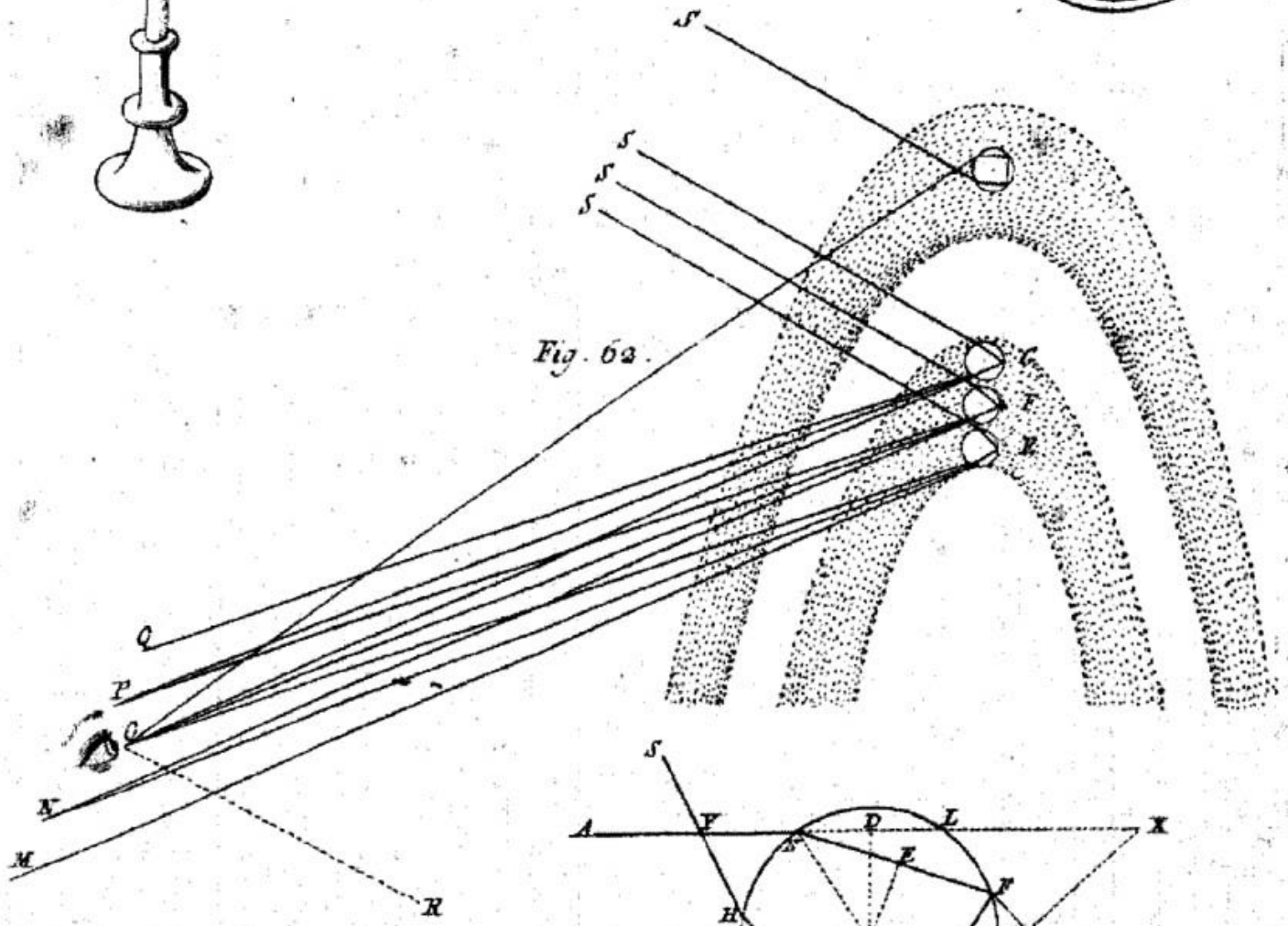

Fig. 61.

